

# Operating Instructions

## 150 RPX Pressure Roller and Spray System



309388

Rev. J

– For roller and portable spray application of architectural paints and coatings –

### Model 233687, Series B

2800 psi (193 bar, 19 MPa) Maximum Working Pressure\*

\* The best operating pressure is the lowest pressure that provides an even paint supply to the roller and typically does not exceed 300 psi (2.1 MPa, 21 bar).

Also Includes: Contractor™ In-line Valve 244161 and Pressure Roller 244279

- 20 in. (50 cm) heavy-duty extension
- 3/16 in. x 25 ft DuraFlex™ hose
- 9 in. (23 cm) roller frame
- 1/2 in. (13 mm) nap roller cover

--	--	--	--	--	--	--	--	--	--

Use water based or mineral spirit-type material only. Do not use materials having flash points lower than 70° (21°). For information about your material request MSDS from distributor or retailer.



### Important Safety Instructions

Read all warnings and instructions in this manual. Save these instructions.

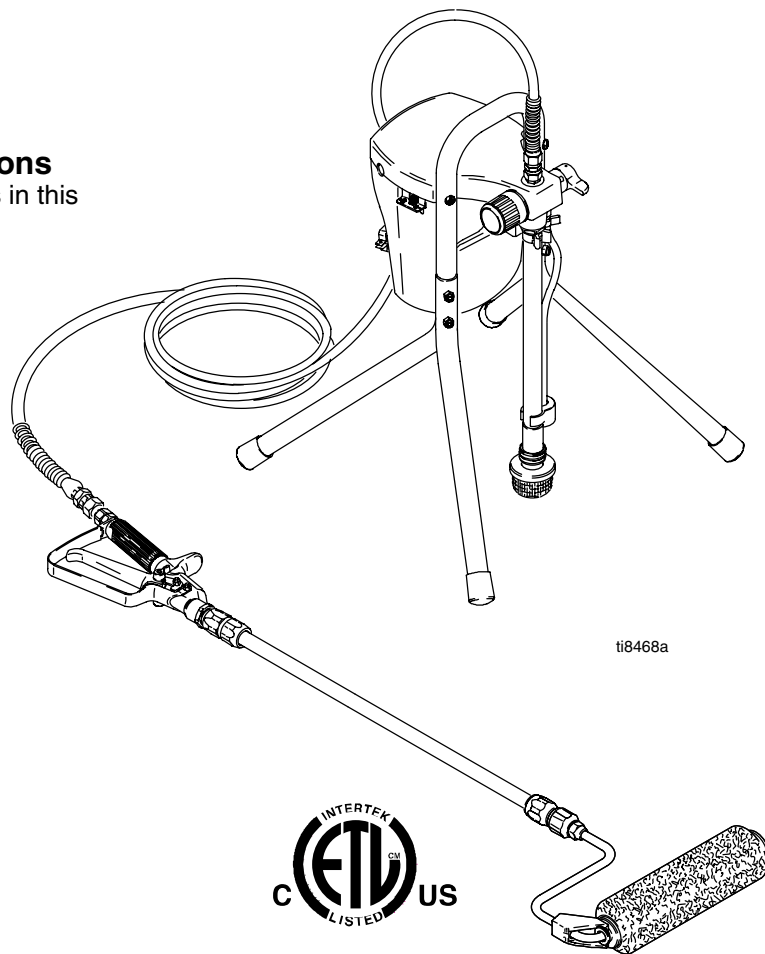

### Table of Contents

Warnings .....	2
Pressure Relief .....	6
Component Identification .....	7
Setup .....	8
Priming .....	9
Operation .....	13
Cleanup .....	17
Trouble Shooting .....	28
Service .....	31
Parts .....	36
Technical Information .....	42
Graco Warranty .....	44
Graco Phone Number .....	44



GRACO INC. P.O. BOX 1441 MINNEAPOLIS, MN 55440-1441

©COPYRIGHT 2001, GRACO INC.

Graco Inc. is registered to I.S. EN ISO 9001



# Specifications

This equipment is not intended for use with flammable or combustible materials used in places such as cabinet shops or other “factory” or fixed locations. If you intend to use this equipment in this type of application, you must comply with NFPA 33 and OSHA requirements for the use of flammable and combustible materials.

The following are general warnings related to the setup, use, grounding, maintenance, and repair of this equipment. Additional, more specific warnings may be found throughout the body of this manual where applicable. Symbols appearing in the body of the manual refer to these general warnings. When these symbols appear throughout the manual, refer back to these pages for a description of the specific hazard.

## WARNING



### **FIRE AND EXPLOSION HAZARD**

Flammable fumes, such as solvent and paint fumes, in work area can ignite or explode. To help prevent fire and explosion:



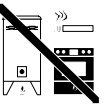

- Use equipment only in well ventilated area.
- Eliminate all ignition sources; such as pilot lights, cigarettes, portable electric lamps, and plastic drop clothes (potential static arc).
- Sprayer generates sparks. When flammable liquid is used in or near sprayer or for flushing or cleaning, keep sprayer at least 20 ft (6 m) away from explosive vapors.
- Keep work area free of debris, including solvent, rags and gasoline.
- Do not plug or unplug power cords or turn lights on or off when flammable fumes are present.
- Ground equipment and conductive objects in work area. Read Grounding instructions.
- If there is static sparking or you feel a shock, stop operating immediately. Do not use equipment until you identify and correct the problem.
- Keep a fire extinguisher in the work area.



### **ELECTRIC SHOCK HAZARD**

Improper grounding, setup, or usage of the system can cause electric shock.

- Turn off and disconnect power cord before servicing equipment.
- Use only grounded electrical outlets
- Use only 3–wire extension cords.
- Ensure ground prongs are intact on sprayer and extension cords.
- Do not expose to rain. Store indoors.

	<p><b>SKIN INJECTION HAZARD</b></p> <p>High pressure fluid from gun, hose leaks, or ruptured components will pierce skin. This may look like just a cut, but it is a serious injury that can result in amputation. <b>Get immediate surgical attention.</b></p> <ul style="list-style-type: none"> <li>• Do not point gun at anyone or any part of the body.</li> <li>• Do not put your hand over the spray tip.</li> <li>• Do not stop or deflect leaks with your hand, body, glove, or rag.</li> <li>• Engage trigger lock when not spraying.</li> <li>• Follow Pressure Relief Procedure in this manual, when you stop spraying and before cleaning, checking or servicing equipment.</li> </ul>
 <p>INSTRUCTIONS</p>	<p><b>EQUIPMENT MISUSE HAZARD</b></p> <p>Misuse can cause death or serious injury.</p> <ul style="list-style-type: none"> <li>• Do not exceed the maximum working pressure or temperature rating of the lowest rated system component. Read <b>Technical Data</b> in all equipment manuals.</li> <li>• Use fluids and solvents that are compatible with equipment wetted parts. Read <b>Technical Data</b> in all equipment manuals. Read fluid and solvent manufacturer's warnings. For complete information about your material, request MSDS from distributor or retailer.</li> <li>• Check equipment daily. Repair or replace worn or damaged parts immediately with genuine Graco replacement parts only.</li> <li>• Do not alter or modify equipment.</li> <li>• Use equipment only for its intended purpose. Call your Graco distributor for information.</li> <li>• Route hoses and cables away from traffic areas, sharp edges, moving parts and hot surfaces.</li> <li>• Do not kink or overbend hoses or use hoses to pull equipment.</li> <li>• Keep children and animals away from work area.</li> <li>• Do not operate the unit when fatigued or under the influence of drugs or alcohol.</li> <li>• Comply with all applicable safety regulations.</li> </ul>
	<p><b>PRESSURIZED ALUMINUM PARTS HAZARD</b></p> <p>Do not use 1,1,1-trichloroethane, methylene chloride, other halogenated hydrocarbon solvents or fluids containing such solvents in this equipment. Such use could result in a serious chemical reaction, with the possibility of explosion, which could cause death, serious injury and/or substantial property damage.</p>
	<p><b>TOXIC FLUID HAZARD</b></p> <p>Toxic fluid or fumes can cause serious injury or death if splashed in the eyes or on skin, inhaled, or swallowed.</p> <ul style="list-style-type: none"> <li>• Read MSDS's to know the specific hazards of the fluids you are using.</li> <li>• Store hazardous fluid in approved containers and dispose of it according to all applicable guidelines.</li> </ul>
	<p><b>PERSONAL PROTECTIVE EQUIPMENT</b></p> <p>You must wear appropriate protective equipment when operating, servicing, or when in the operating area of the equipment to help protect you from serious injury, including eye injury, inhalation of toxic fumes, burns, and hearing loss. This equipment includes, but is not limited to:</p> <ul style="list-style-type: none"> <li>• Protective eye wear.</li> <li>• Clothing and respirator as recommended by the fluid and solvent manufacturer.</li> <li>• Gloves.</li> <li>• Hearing protection.</li> </ul>

# Grounding and Electric Requirements

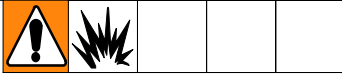

The sprayer must be grounded. Grounding reduces the risk of static and electric shock by providing an escape wire for the electrical current due to static build up or in the event of a short circuit.

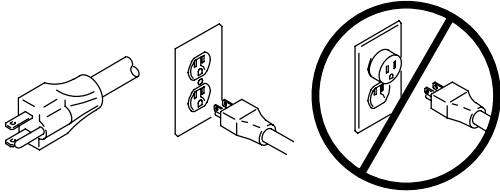

ti3001b

- **The sprayer requires** a 120V AC, 60 Hz, 15A circuit with grounding receptacle. Never use an outlet that is not grounded or an adapter.



ti5572a

- Do not use the sprayer if the electrical cord has a damaged ground prong. Only use an extension cord with an undamaged, 3-prong plug.
- **Recommended extension cords** for use with this sprayer:
  - 25 ft (7.6 m) 18 AWG
  - 50 ft (15.2 m) 16 AWG
  - 100 ft (30.5 m) 14 AWG
  - 150 ft. (45.7 m) 12 AWG

Smaller gauge or longer extension cords may reduce sprayer performance.

- **Ground sprayer gun** through connection to a properly grounded fluid hose and pump.

- **Ground fluid supply container.** Follow local code.

# Grounding and Electric Requirements

- **Ground solvent pails used when flushing.** Follow local code. Use only conductive, metal pails, placed on a grounded surface such as concrete. Do not place the pail on a non-conductive surface such as paper or cardboard, which interrupts the grounding continuity.

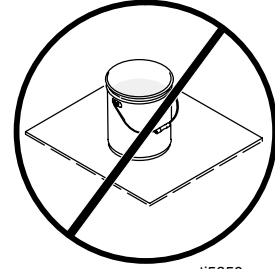

ti5850a

- **Ground the metal pail** by connecting a ground wire to the pail by clamping one end to pail and the other end to ground such as as water pipe.

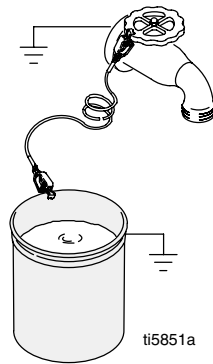

ti5851a

- **Maintain grounding continuity** when flushing or relieving pressure by holding metal part of spray gun firmly to side of a grounded metal pail, then trigger gun.

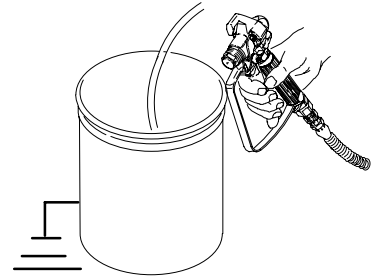

## Thermal Overload



To reduce risk of injury from motor starting unexpectedly when it cools, always turn power switch OFF if motor shuts down.

- Motor has a thermal overload switch to shut itself down if overheated.

# Pressure Relief Procedure

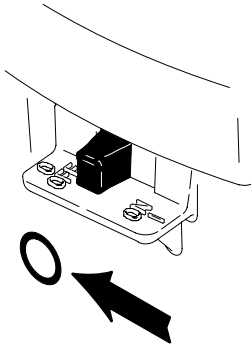

1. Turn power switch OFF and unplug power cord.



PRIME

2. Turn Spray-Prime/Drain valve to PRIME/DRAIN to relieve pressure.

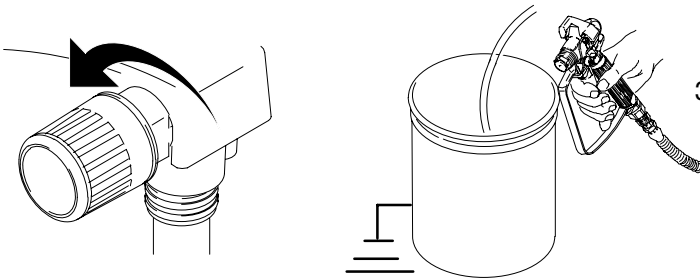

3. Turn pressure to lowest setting. Hold metal part of gun firmly to a grounded metal pail. Trigger gun to relieve pressure.

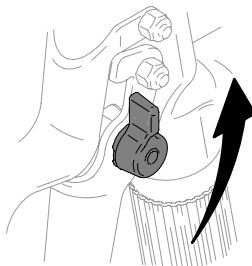

4. Engage trigger lock.



PRIME

- Leave Spray-Prime/Drain valve in PRIME/DRAIN position until you are ready to spray again.
- *If you suspect the spray tip is clogged or that pressure has not been fully relieved after following the above steps, VERY SLOWLY loosen tip guard retaining nut or hose end coupling to relieve pressure gradually. Then loosen completely. Clear hose or tip obstruction.*

# Component Identification

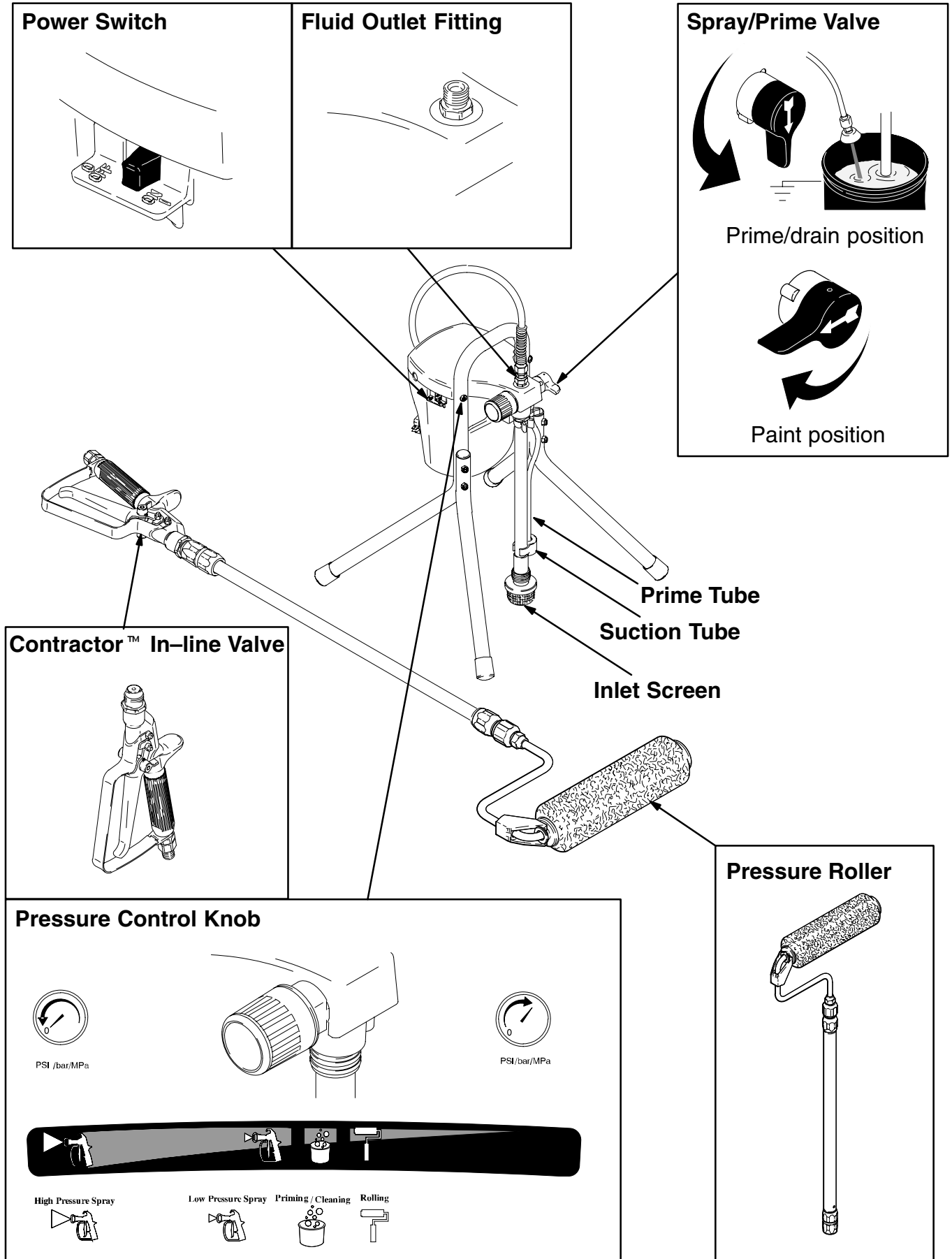

# Setup

---

1. Turn power switch OFF.

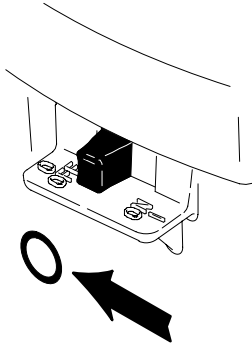

- 
2. Connect one end of grounded fluid hose to the In-line Valve. Use a wrench to tighten.

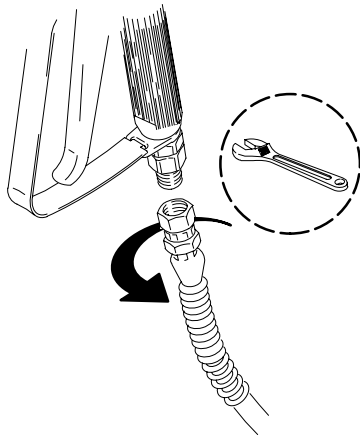

**NOTE: The Contractor™ In-line Valve can be used as an airless spray gun for small jobs by attaching a Handtite™ Guard and RAC5 Switchtip.**

**For larger jobs the sprayer can be used for airless spraying by attaching an airless spray gun rated at 2800 psi (193 bar, 19 MPa) Maximum Working Pressure or higher.**

- 
3. Connect other end of hose to sprayer fluid outlet fitting. Use a wrench to tighten.

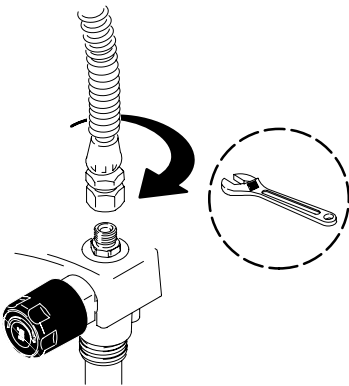

- 
4. Turn pressure control knob all the way left (counterclockwise) to minimum pressure.

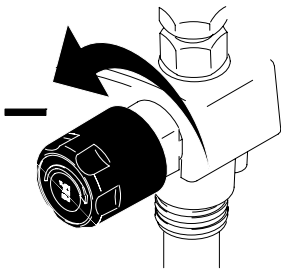



# Priming – For flushing factory or storage fluid and loading pump with water

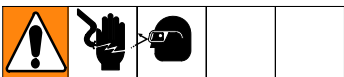

1. Turn Spray/Prime valve to PRIME.

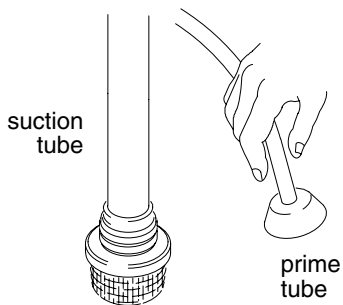
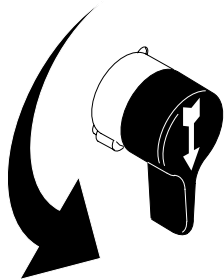

2. Separate the (smaller) prime tube from the (larger) suction tube.

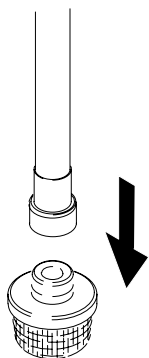

3. Unscrew inlet screen from suction tube.

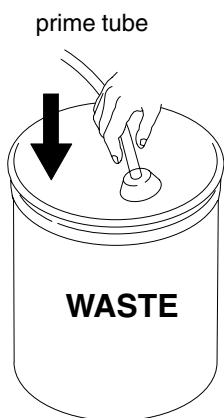

4. Place prime tube in waste pail.

# Priming – For flushing factory or storage fluid and loading pump with water

Power Flush attachment

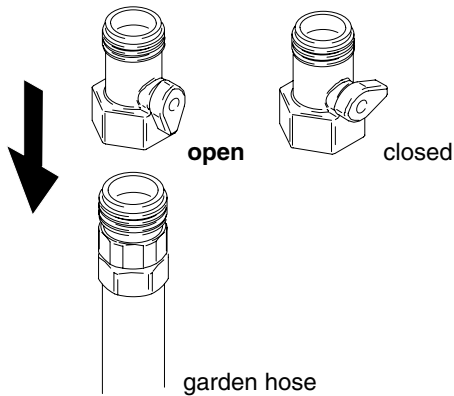

5. Screw Power Flush attachment (included with sprayer) onto garden hose and OPEN Power Flush attachment.

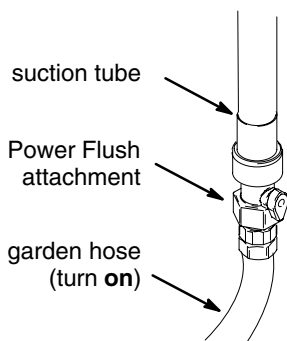

6. Screw garden hose and Power Flush attachment onto suction tube and turn ON garden hose.

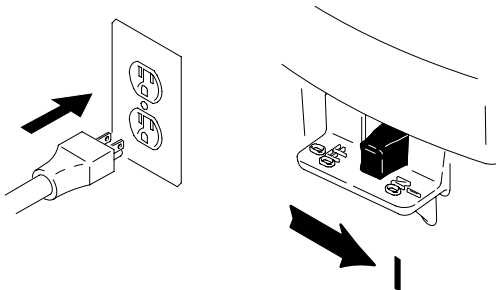

7. Plug sprayer in to grounded outlet and turn power switch ON.

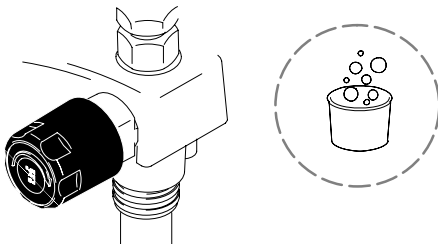

8. Align arrow on sprayer pressure control knob to (bucket symbol) until the pump starts.



30 to 60  
seconds



9. Let water flow out of prime tube into waste pail for 30 to 60 seconds. Water flowing out of prime tube indicates pump is primed with water.

# Priming – For flushing water and loading pump and hose with paint

---

1. Turn power switch OFF.

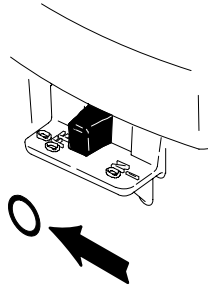

2. Turn Power Flush to closed position and garden hose OFF. Unscrew Power Flush attachment from suction hose.

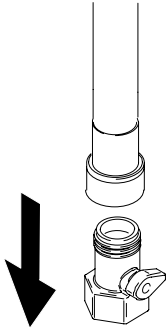

3. Screw inlet screen onto suction tube.

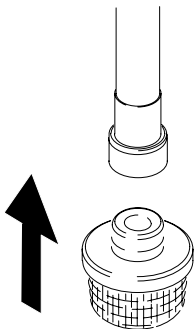

4. Submerge suction tube in paint.

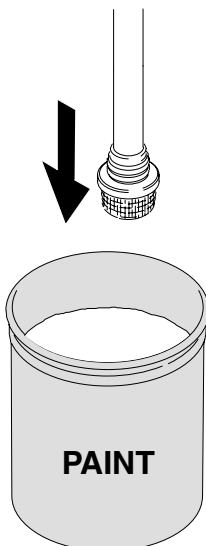

# Priming – For flushing water and loading pump and hose with paint

---

5. Point In-line Valve into waste pail.



6. Turn power switch ON.

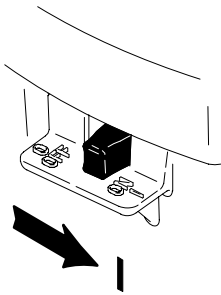

7. When paint starts to come out of prime tube, pull and hold In-line Valve trigger and turn Spray/Prime valve to spray. When paint comes out of In-line Valve release trigger.

**NOTE: The motor stopping indicates the pump and hose are primed with paint.**

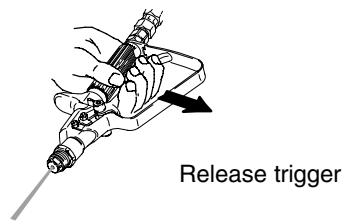
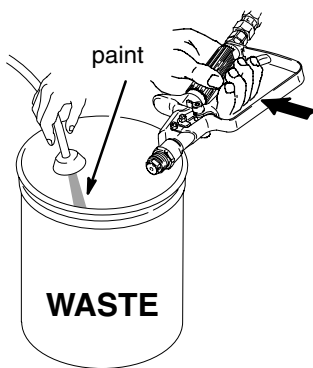

8. Transfer prime tube to paint pail.

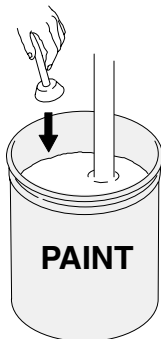

# Operation

---

1. Engage the In-line Valve safety latch.

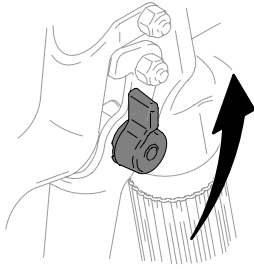

2. Firmly tighten pressure roller to 20" extension.

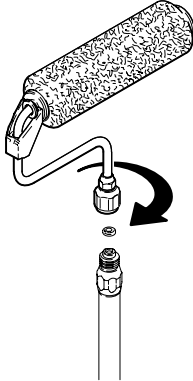

3. Attach pressure roller assembly to In-line Valve. Use a wrench to tighten.

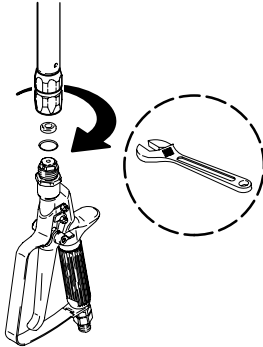

4. Turn pressure control knob to roller symbol.

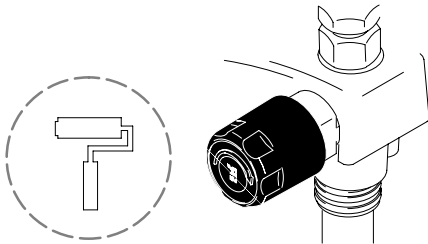

5. Disengage In-line Valve safety latch. Trigger In-line Valve and roll the surface until paint comes to roller.

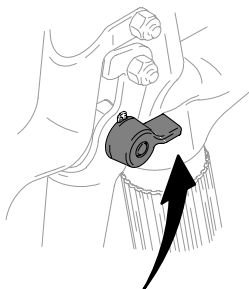

**NOTE:** Trigger the In-line Valve briefly only when you need more paint. Determine how often you must trigger the gun to maintain an even paint supply to the roller.

# Operation

---

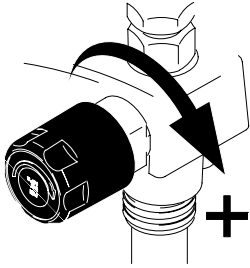

6. Increase pump pressure **only** if triggering In-line Valve cannot supply enough paint for your rolling speed.



7. Whenever you stop painting, **relieve pressure**, page 6, and elevate roller end of extension tube to prevent paint from draining out.

Flush the pump, In-line Valve and pressure roller immediately after each use to prevent paint from drying in the pressure roller and damaging it. **Cleanup** page 17.

# Rolling Techniques

---

1. Rolling vertically, roll out the letter "M".

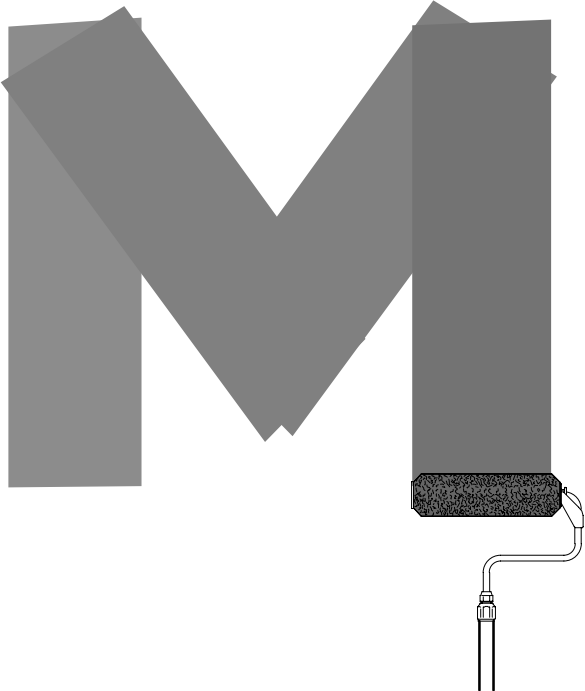

2. Cross roll, horizontally, to spread the paint.

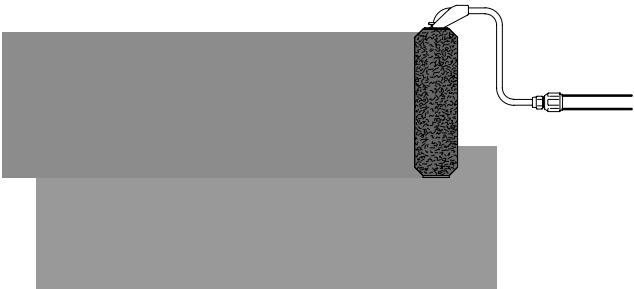

3. Finish with light vertical strokes until the entire area has been evenly covered.

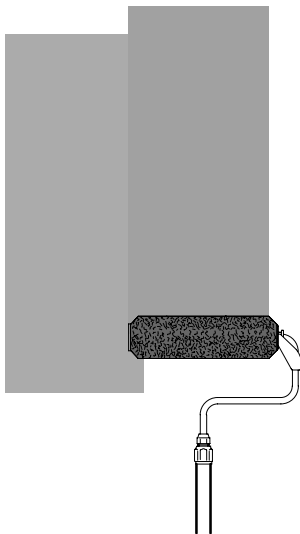

# Ceilings, Woodwork and Walls

---

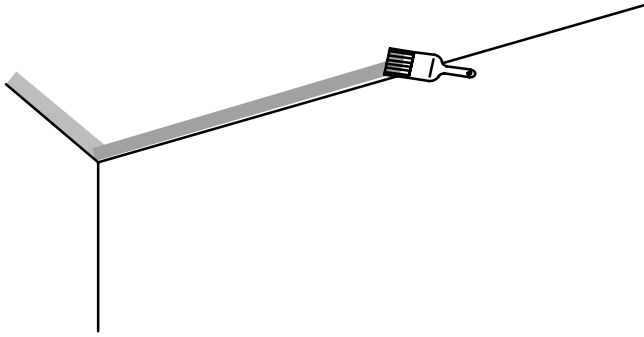

1. **Ceilings:** Using a paint brush, apply a starting row of paint approximately the width of your brush where the walls and ceiling meet.

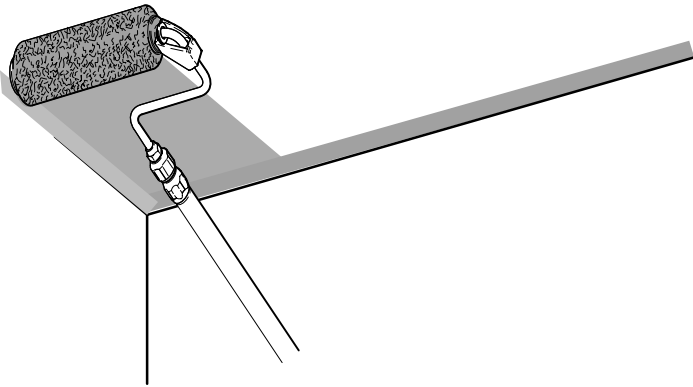

2. With the roller, apply paint to the ceiling, working the short way of the room and applying as wide a strip as possible.

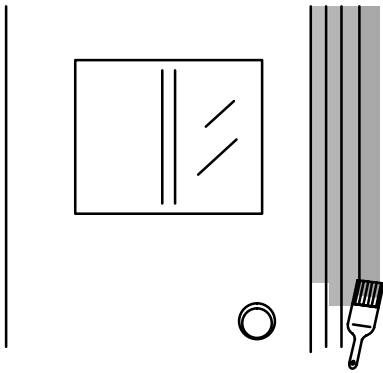

1. **Woodwork & Walls:** Using a brush, paint woodwork first. Apply a starting row of paint approximately the width of the paint brush around the woodwork and where the walls meet the ceiling.

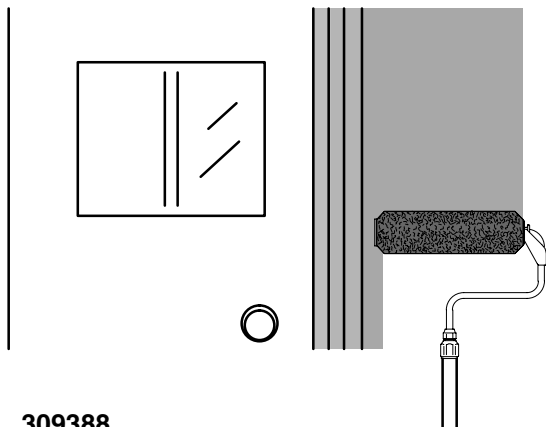

2. With the roller, apply paint to the walls, following the Roller Techniques described on page 15.



# Cleanup

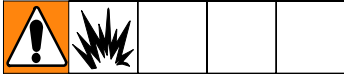

Leave the roller assembly attached to the In-line Valve for this procedure.

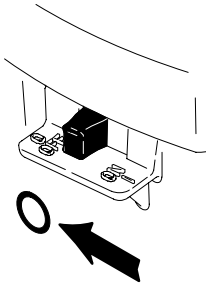

1. **Relieve the pressure.** Turn power switch OFF.

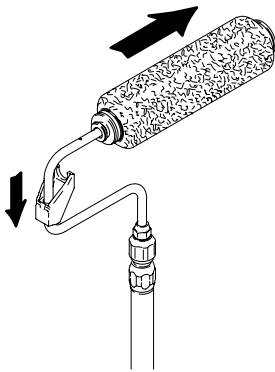

2. Remove roller cover and diffuser from roller frame as follows:
  - a. Using your thumb, slide clip down and release end caps, diffuser, and roller cover into a pail.

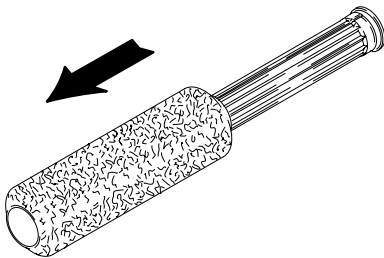

- b. Remove roller cover from diffuser.

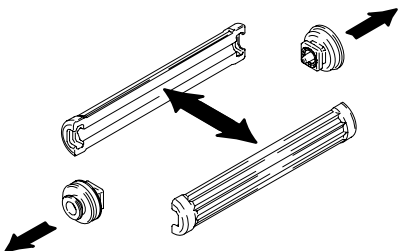

- c. Pull end caps off diffuser.

## Cleanup (continued)

---

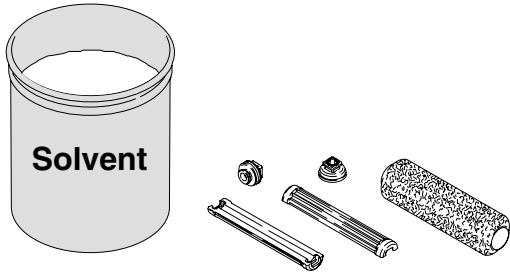

3. Clean roller cover, caps and diffuser with water or a compatible solvent for non-water-based materials.



4. Place roller frame in paint pail. Be sure the holes in the frame are facing inside the paint pail.

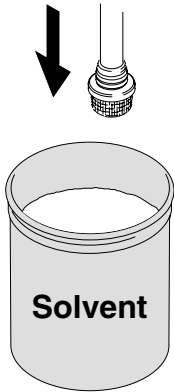

5. Place suction tube in bucket of water or compatible solvent for non-water-based materials.

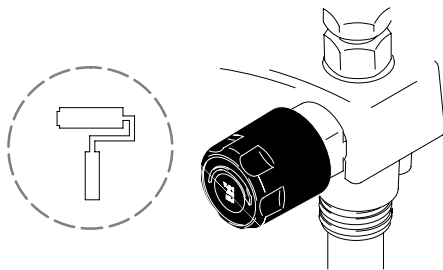

6. Turn pressure control knob to roller symbol.

# Cleanup (continued)

7. Turn power switch ON.

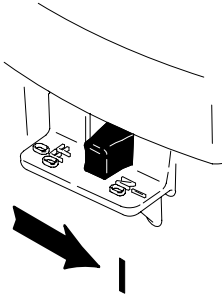

8. Trigger In-line Valve.

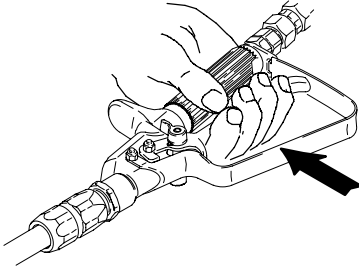

9. Turn Spray/Prime valve to SPRAY.



10. Continue to trigger In-line Valve until flushing fluid begins to dilute paint. Then release In-line Valve trigger.



11. Place roller frame in another bucket.

If you are flushing a non-water-based fluid, flush until fluid coming out of roller frame is clear. Proceed to page 25, Cleanup—Cleaning Contractor™ In-line Valve Filter.

If water-based, follow Power Flushing procedure, page 20.



12. **Relieve pressure**, page 6. Turn power switch OFF.

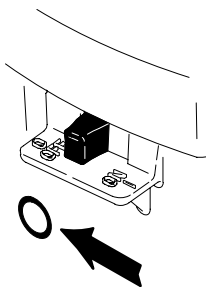

# Cleanup – Power Flushing After Spraying Water-based Paint



1. Relieve pressure, page 6. Turn power switch OFF.

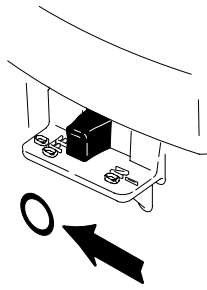

Power Flush attachment

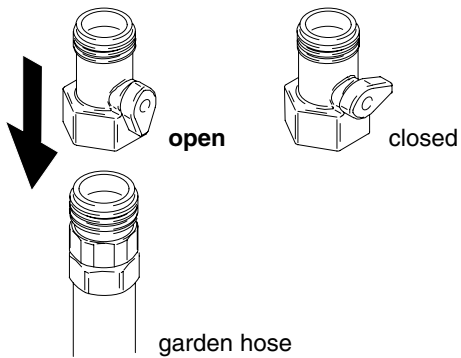

2. Screw Power Flush attachment onto garden hose.

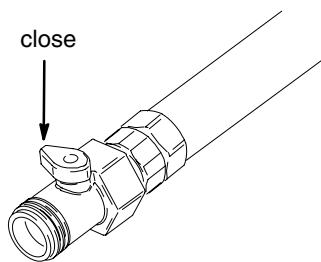

3. Turn lever to close Power Flush attachment.

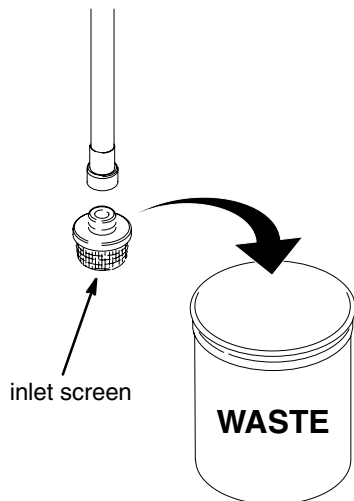

4. Unscrew inlet screen from suction tube and place in waste pail.

# Cleanup – Power Flushing After Spraying Water-based Paint – (continued)

5. Connect garden hose to suction tube with Power Flush attachment. **Leave prime tube in waste pail.**

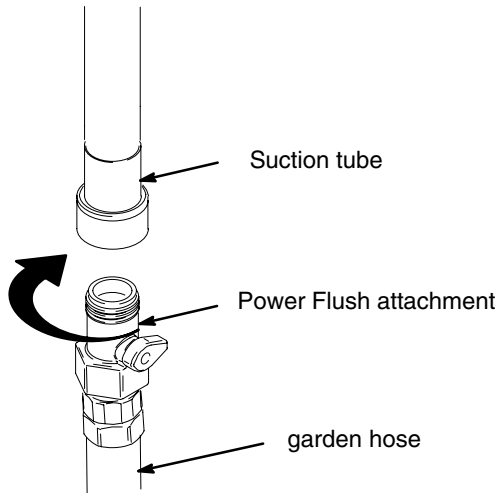

6. Turn lever to open Power Flush attachment. Turn on garden hose.

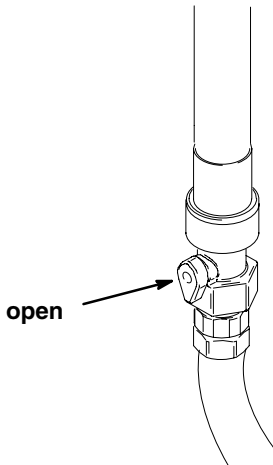

7. Align arrow on sprayer with bucket symbol on Pressure Knob.

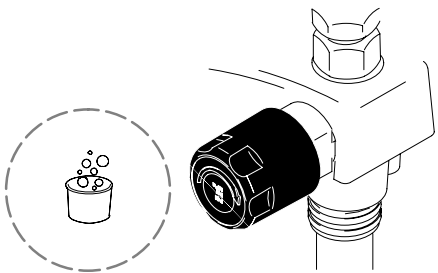

8. Turn power switch ON.

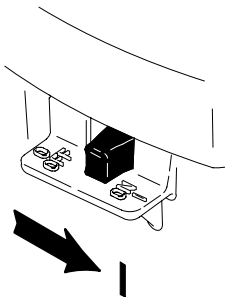

# Cleanup – Power Flushing After Spraying Water-based Paint – (continued)

---

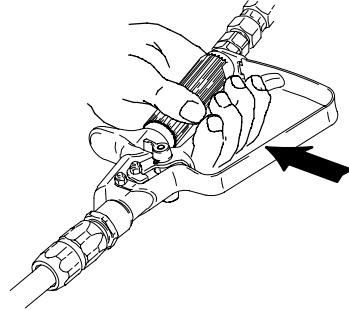

9. Place roller frame in waste pail and trigger In-line Valve. Be sure the holes of the roller frame are facing inside the pail.

- 
10. Turn Spray/Prime Valve to SPRAY.

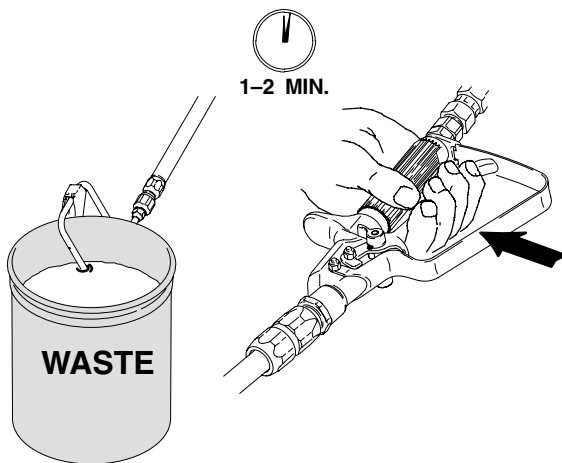

11. Keep In-line Valve triggered for 1–2 minutes until somewhat clear water flows out of roller frame.

# Cleanup – Power Flushing After Spraying Water-based Paint – (continued)

---

12. Turn Spray/Prime Valve to PRIME.



13. Let water flow through sprayer into waste pail for 20 seconds.

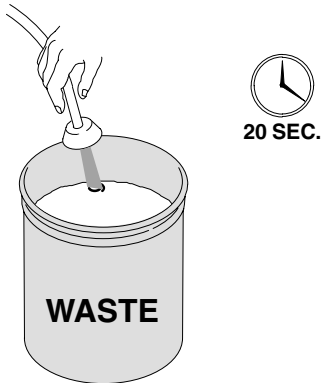

14. Turn Power Switch OFF.

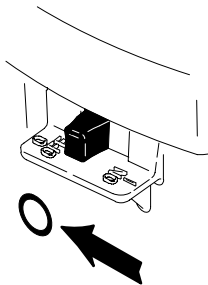

# Cleanup – Power Flushing After Spraying Water-based Paint – (continued)

---

15. Close Power Flush. Turn off garden hose.

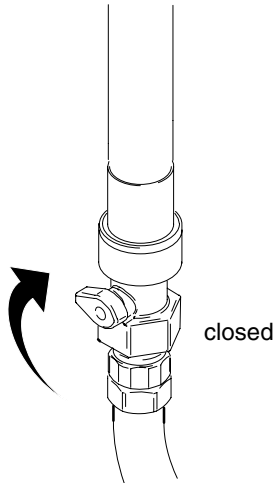

16. Unscrew Power Flush attachment from suction hose.

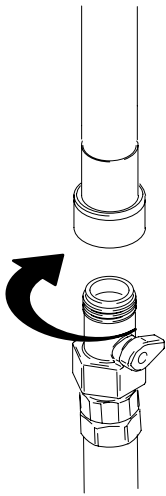

17. Remove roller frame and extension from In-line Valve.

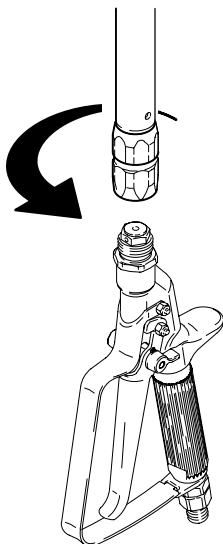



# Cleanup – Cleaning Contractor™ In-line Valve Filter



1. Relieve pressure, page 6.

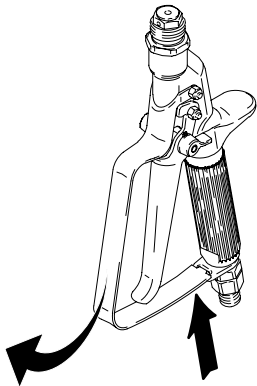

2. Push up on the trigger guard and swing it away from the trigger.

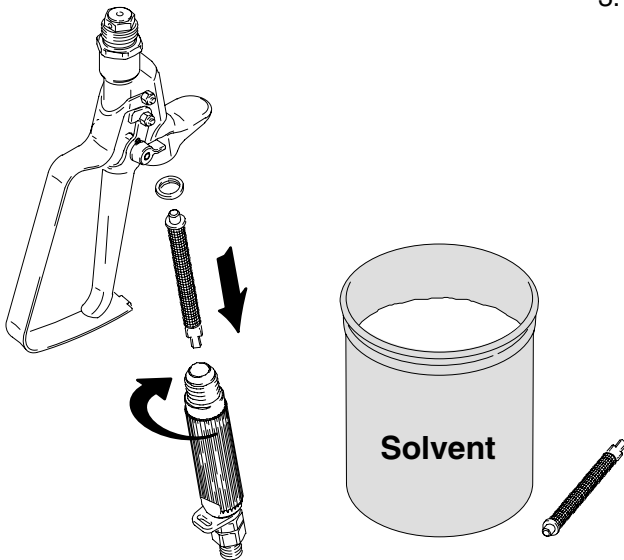

3. Unscrew the In-line Valve handle from the housing. Remove the filter and clean it in compatible solvent.

**NOTE: Do not soak the entire In-line Valve in solvent. Prolonged exposure to solvent can ruin the packings.**

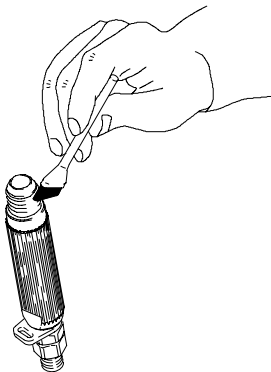

4. Apply Lithium-based greased to the threads of the In-line Valve handle and reassemble In-line Valve.

# Cleanup – Filling the Sprayer with Storage Fluid

---

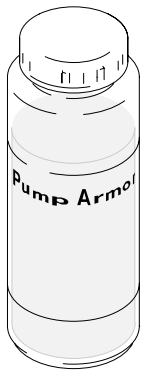

Always pump storage fluid through the pump system after cleaning. Water left in the sprayer will corrode and ruin pump.

suction tube

prime tube

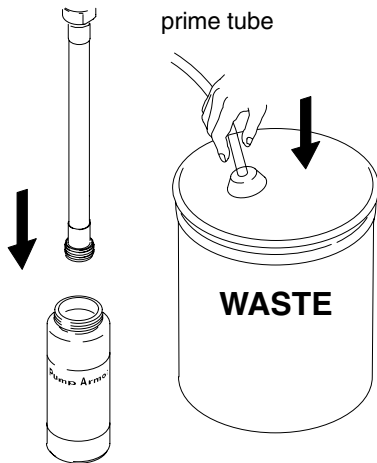

1. Place suction tube in storage fluid bottle and prime tube in waste pail.



2. Turn Prime/Spray valve to PRIME.

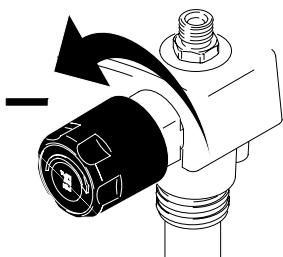

3. Turn Pressure Control knob all the way left (counterclockwise) to minimum pressure.

# Cleanup – Filling the Sprayer with Storage Fluid

---

4. Turn power switch ON.

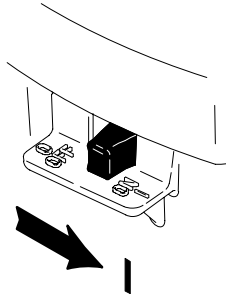

5. Align arrow on the sprayer with the (roller symbol) on the Pressure Control knob.

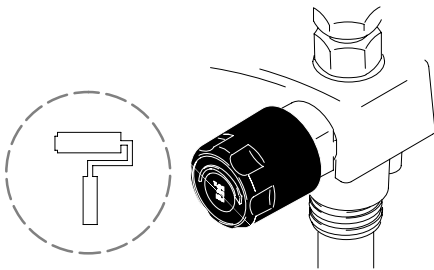

watch for storage fluid from prime tube (in 5 to 10 seconds)

6. When storage fluid comes out of prime tube (in 5–10 seconds) turn power switch OFF.

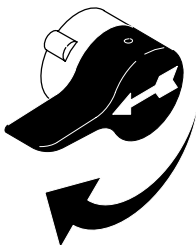
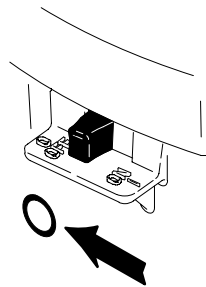
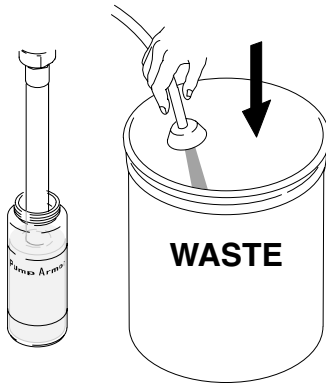

7. Turn Spray/Prime valve to SPRAY to keep storage fluid in sprayer during storage.

# Troubleshooting

Check everything in this Troubleshooting table before you bring the sprayer to a Graco authorized service center.

PROBLEM	CAUSE	SOLUTION
Pump will not prime. HINT: <ul style="list-style-type: none"> <li>• Attempt to free check balls by tapping side of inlet valve as sprayer is stroking.</li> <li>• Strain paint before spraying and keep sand and debris out.</li> <li>• Thoroughly flush after every paint job.</li> <li>• Do not store in water. Use Pump Armor or mineral spirits.</li> </ul>	Spray/Prime valve is set at SPRAY.	Turn Spray/Prime valve to PRIME (pointing down).
	Spray/Prime valve is plugged	Clean/replace drain tube as necessary. See Graco authorized service center if drain valve is plugged.
	Inlet screen is clogged or suction tube is not immersed.	Clean debris off inlet screen. Make sure suction tube is at bottom of paint pail.
	Inlet valve check ball is stuck.	Remove the tube and place a pencil into the inlet section to dislodge the ball, allowing the pump to prime properly. OR <b>Power Flush</b> the unit (page 20).
	Outlet valve check ball is stuck.	Remove hose from sprayer. Unscrew outlet valve to remove assembly. Gently nudge the ball in the outlet assembly with a screwdriver. Screw the valve back into the pump.
Power switch is on and sprayer is plugged in, but pump does not cycle.	Electrical outlet is not providing power or extension cord is damaged or sprayer power cord is damaged.	Try a different outlet or reset building circuit breaker or replace extension cord/power cord.
	Pressure is set at minimum.	Turn Pressure Control Knob to the right (clockwise) to increase pressure.
	Motor or control is damaged.	Return sprayer to Graco authorized service center.
	Paint is frozen or hardened in pump.	<b>Unplug sprayer from electrical outlet.</b> <b>NOTE: If frozen, do not try to start sprayer until completely thawed,</b> or damage to motor, control board, and/or drivetrain may occur.  Make sure power switch is OFF. Place sprayer in warm area for several hours, then plug in and turn on. Slowly increase pressure setting to see if motor starts.  If paint hardened in sprayer, pump packings, valves, drivetrain, or pressure switch may need to be replaced.
Cannot pull In-line Valve trigger.	Trigger safety is in SAFETY ON position.	Put trigger safety in SAFETY OFF position.
In-line Valve stops spraying.	Tip is clogged.	Aim In-line Valve into waste pail. Squeeze trigger.
Pump cycles but does not build up pressure. (i.e., will not stop cycling even though gun trigger is released)	Pump check valves are dirty or damaged.	Clean or replace check valves.
	Spray/Prime valve is worn or obstructed with debris.	Return sprayer to Graco authorized service center.
	Pump is not primed.	See <b>Priming</b> on page 9.
	Inlet screen is clogged or suction tube is not immersed.	Clean debris off inlet screen. Make sure suction tube is at bottom of pail. Reprime sprayer.
	Paint pail is empty.	Refill paint pail and reprime sprayer.
	Suction tube has vacuum air leak.	Tighten suction tube connection. Inspect for cracks or vacuum leaks. If cracked or damaged, replace suction tube.
	Pump check ball is stuck.	See "Pump will not prime" section of <b>Trouble Shooting</b> instructions.

# Troubleshooting

PROBLEM	CAUSE	SOLUTION
Pump cycles but paint only dribbles or spurts when trigger is pulled.	Pressure is set too low.	Turn Pressure Control Knob to the right (clockwise) to increase pressure.
	Tip is clogged.	Clear tip. See your gun manual.
	Spray tip is too large or worn.	Replace tip.
	Gun filter is clogged.	Clean or replace In-line Valve fluid filter. Page 25.
Pressure is set at maximum, but cannot achieve a good spray pattern.	Extension cord is too long or not a heavy enough gauge.	Replace extension cord.
	Tip is too large for sprayer.	Select a smaller tip.
	Tip is worn beyond capability of sprayer.	Replace tip.
	Gun filter is clogged.	Clean or replace In-line Valve fluid filter. Page 25.
	Inlet screen is clogged.	Clean debris off inlet screen.
	Pump valves are worn.	Check for worn pump valves as follows: Prime sprayer with paint. See <b>Priming</b> on page 9. Trigger In-line Valve momentarily. When trigger is released, pump should cycle momentarily and stop. If pump continues to cycle, pump valves may be worn. Replace check valves.
When paint is sprayed, it runs down the wall or sags.	Coat is going on too thick.	Move gun faster.
		Choose tip with smaller hole size.
		Choose tip with wider fan.
		Make sure gun is far enough from surface.
When paint is sprayed, coat is not covering.	Coat is going on too thin.	Move gun slower.
		Choose tip with larger hole size.
		Choose tip with narrower fan.
		Make sure gun is close enough to surface.
Motor is hot and runs intermittently. <b>NOTE:</b> This is a thermal overload condition. Motor will automatically shut off due to excessive heat. See <b>Startup Hazard After Thermal Overload</b> on page 2. Damage can occur if cause is not corrected.	Vent holes in shroud are plugged, or sprayer is covered.	Keep vent holes in shroud clear of obstructions and overspray, and keep sprayer open to air.
	Extension cord is too long or not a heavy enough gauge.	Replace extension cord.
	Unregulated electrical generator being used has excessive voltage.	Use electrical generator with a proper voltage regulator. Sprayer requires a 120V AC, 60 Hz, 1500-Watt generator.
	Sprayer was operated at high pressure with small tip, which caused frequent motor starts and excessive heat build up.	Decrease pressure setting, or increase tip size.
Building circuit breaker opens after sprayer operates for 5 to 10 minutes. <b>OR</b> Building circuit breaker opens as soon as sprayer is plugged into outlet, and sprayer is turned on.	Too many appliances are plugged in on same circuit.	Free up circuit (unplug things), or use a less busy circuit.
	Extension cord is damaged or too long or not a heavy enough gauge.	<ul style="list-style-type: none"> <li>● Plug in something that you know is working to test extension cord.</li> <li>● Replace extension cord.</li> </ul>
	Sprayer power cord is damaged.	Check for broken insulation or wires. Replace power cord if damaged.

Fan pattern varies dramatically while spraying or sprayer does not turn on promptly when resuming spraying.	Pressure control switch is worn and causing excessive pressure variation.	Return sprayer to Graco authorized service center.
Spray comes out of gun in two thick streams.	Reversible tip is in UNCLOG position.	Rotate arrow-shaped handle on tip so it points forward in SPRAY pattern.
Sprayer does not turn on promptly when resuming spraying.	Pressure control switch is worn and causing excessive pressure variation.	Return sprayer to Graco authorized service center.
Paint is coming out of pressure control switch.	Pressure control switch is worn.	Return sprayer to Graco authorized service center.
Pressure drain actuates automatically, relieving pressure through prime tube.	System is overpressurizing.	Return sprayer to Graco authorized service center.
Paint leaks down outside of pump.	Pump packings are worn.	Replace pump packings.

# Service – Changing the Needle on the Contractor™ In-line Valve



**NOTE:** The needle, diffuser/seat, gasket and locknut must be replaced together. They are included in Repair Kit 218070.

## Disassembly

1. Relieve pressure, page 6.

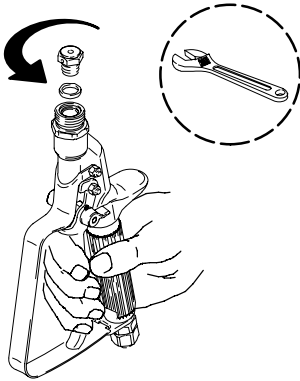

2. Squeeze trigger while unscrewing diffuser/seat and gasket.

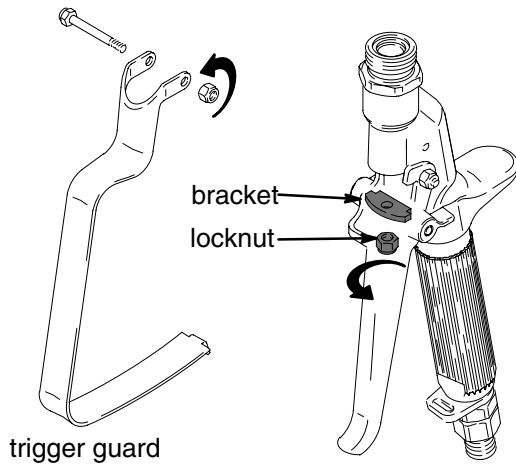

3. Remove Trigger. Remove locknut and bracket.

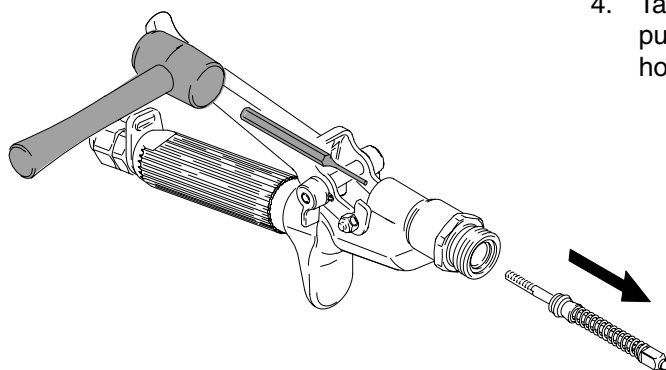

4. Tap rear of the In-line Valve with plastic mallet and punch to push needle assembly out through front of housing.

# Service – Changing the Needle on the Contractor™ In-line Valve

**NOTE:** The needle, diffuser/seat, gasket and locknut must be replaced together. They are included in Repair Kit 218070.

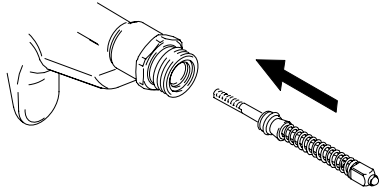

## Reassembly

1. Guide threaded end of needle assembly into front of In-line Valve.

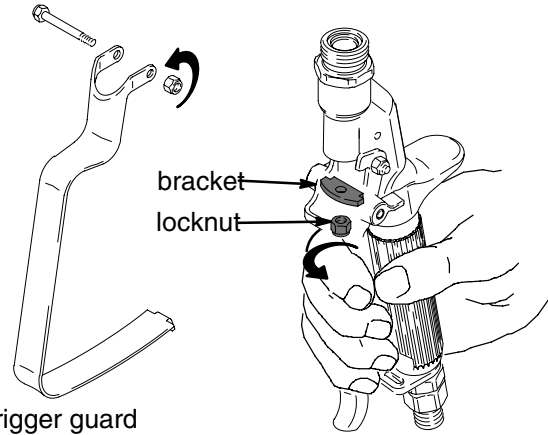

2. Install bracket and locknut loosely on threaded end of needle. Squeeze trigger to pull needle assembly into In-line Valve body. Tighten locknut and install trigger guard.

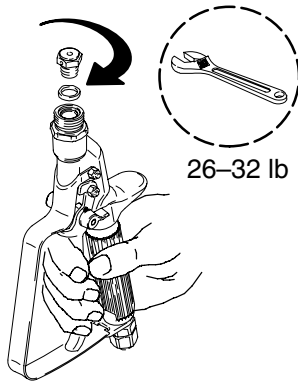

3. Squeeze trigger while installing gasket and diffuser/seat. Torque diffuser/seat to 26-32 ft-lb (35-43 N·M).

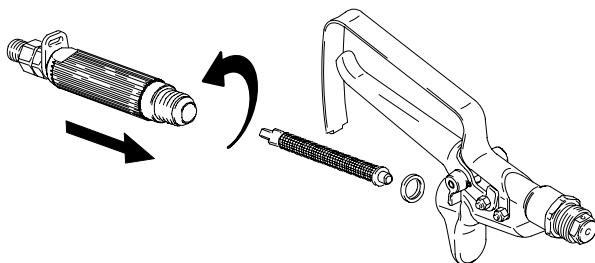

4. If In-line Valve handle was removed, hand tighten into fluid housing. It should fit easily. Be sure trigger guard is reassembled.

5. **Adjust needle before using In-line Valve.**



# Service – Adjusting the Needle on the Contractor™ In-line Valve

1. Engage In-line Valve safety latch.

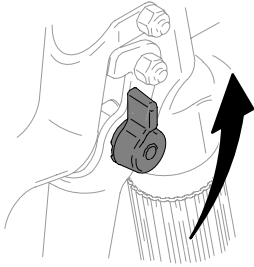

2. Hold In-line Valve with nozzle straight up.

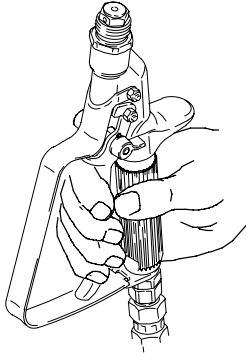

3. Remove trigger guard.

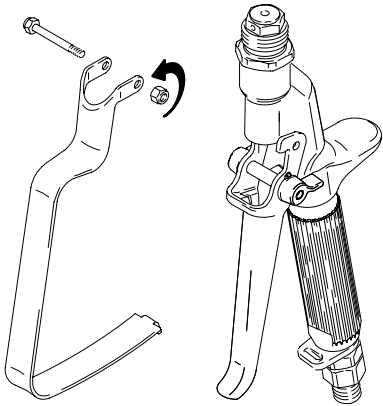

4. Hold your finger against trigger with light pressure. Using a 5/16-in, open ended wrench, turn locknut clockwise until you feel trigger depress slightly.

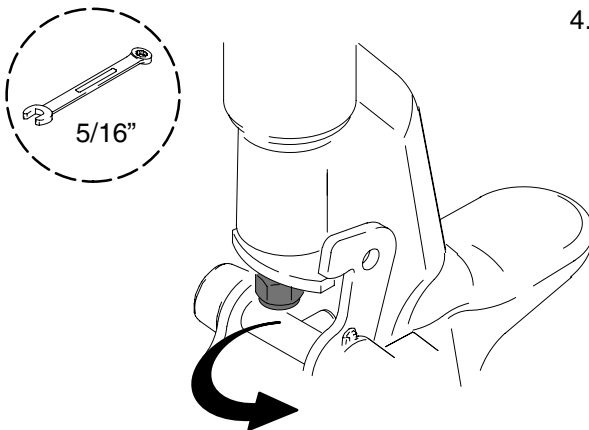

# Service – Adjusting the Needle on the Contractor™ In-line Valve

5. Turn adjusting nut 3/4 turn counterclockwise.

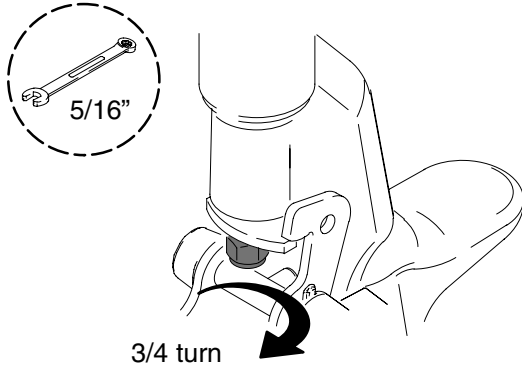

6. Connect fluid hose. Use a wrench to tighten.

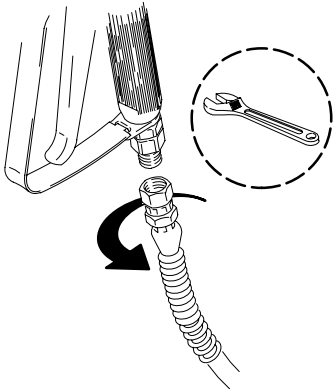

7. Prime system. Page 9.

8. Trigger the In-line Valve and release it. The fluid should stop immediately.

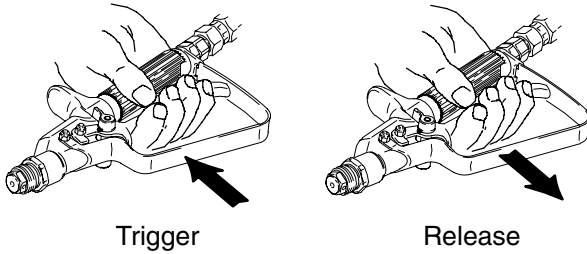

9. Engage safety latch and try to trigger In-line Valve. **NO FLUID SHOULD FLOW.**

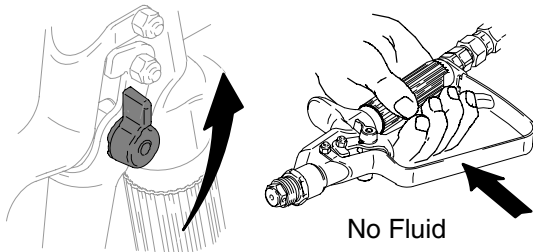

**If the In-line Valve fails either test, relieve pressure, disconnect hoses and readjust needle.**



# Parts

## 150 RPX Model 233687

Ref. No.	Part No.	Description	Qty.	Ref. No.	Part No.	Description	Qty.
1	15A680	FRAME	1	44	245149	KIT, gear, (includes two gears and connecting rod)	1
2	195697	STRAINER	1	50	245078	KIT, pump repair	1
3	244035	DEFLECTOR, barbed	1	51	245079	KIT, control board	1
5	15A473	TUBE, suction	1	52	245080	KIT, motor, repair	1
6	15H772	SUPPORT, frame	1	53	245076	KIT, outlet valve	1
7	196586	COVER, switch	1	54	245077	KIT, inlet valve	1
8	113955	SCREW	4	55	116295	CLAMP, spring, .88 diameter	1
9	102040	NUT, lock	4	56	115478	SCREW, machine; pan head	2
12	15A475	TUBE, drain	1	57	196594	CORD, power	1
13	115489	CLAMP, drain tube	2	58	243954	HOSE, DuraFlex, 3/16 in. x 25 ft (available from Service Center only)	1
23	244266	KIT, pressure switch, repair	1				
30	224807	CAM, drain valve	1				
31	235014	KIT, valve, repair	1				
32	111600	DRIVE PIN, drain valve	1	61▲	196932	LABEL, warning	1
38	187625	HANDLE, drain valve	1	62▲	198668	LABEL, warning	1
41	245148	KIT, motor enclosure (includes enclosure and 2 warning labels)	1	63	115477	SCREW, machine, pan head	9
42	245147	KIT, cover, housing (includes 3 labels, 2 dowel pins, 2 bushings)	1	64	196574	FITTING, drain	1
				66	103473	STRAP, tie	1
				69+	115648	VALVE, shutoff, power flush	1

▲ Replacement Danger and Warning labels, tags and cards are available at no cost.

+ Not shown.



Pressure Roller Assembly Model 244279

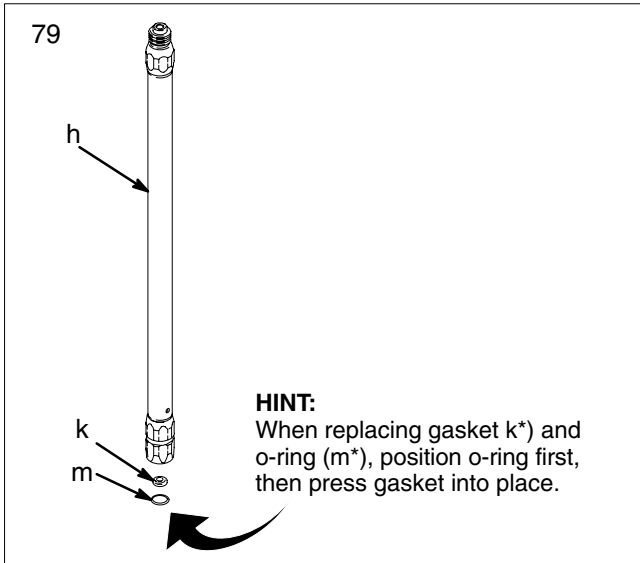
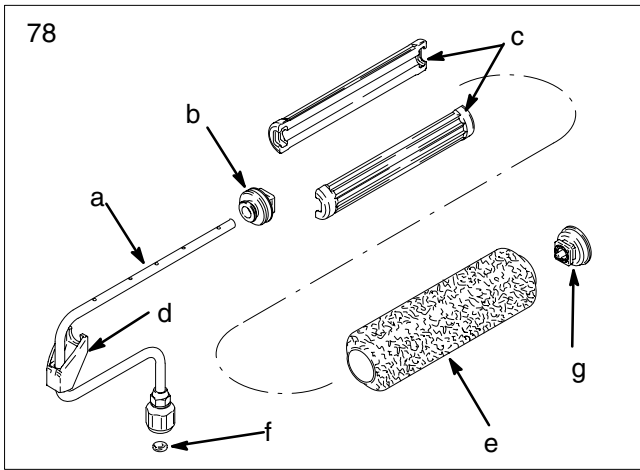

## Parts List

Ref. No.	Part No.	Description	Qty.
<b>78</b>	244271	FRAME, roller includes a, b, c, d, e, f	1
a		FRAME	
b	246277	CAP, end (includes seal, retainer, and o-ring)	1
c	15B065	DIFFUSER	2
d	197106	CLIP, roller	1
e	107590	ROLLER, cover, 9 inch, 1/2 in. (13 mm) nap	1
f	115524	GASKET	1
g	245999	CAP, end (includes seal and retainer)	1
<b>79</b>	232122	EXTENSION, includes h, k, m	
h		EXTENSION, 20 in. (50 cm)	1
k	162863	GASKET	1
m	114049	O-RING	1

## Additional Roller Covers

The following pressure roller covers are available at your local distributor:

- 107590** 9 in. (23 cm); 1/2 in. (13 mm) nap
- 107591** 9 in. (23 cm); 3/4 in. (19 mm) nap
- 107592** 9 in. (23 cm); 1-1/4 in. (32 mm) nap



# Parts List

## Contractor™ In-line Valve Model 244161

Ref. No.	Part No.	Description	Qty.	Ref. No.	Part No.	Description	Qty.
101	218070	NEEDLE-DIFFUSER/SEAT KIT	1	111	197568	HOUSING, fluid, locking	1
102	244193	TRIGGER, valve, In-line	1	112	113409	RETAINER, guard	1
103	196869	GUARD, trigger	1	113	195788	HANDLE, valve	1
104	238817	KIT, swivel	1	114	104938	PACKING, o-ring	1
105✓	218131	FLUID FILTER ASSEMBLY (standard 50 mesh) includes replacement parts 5a, 5b, 5c, 5d	1	119	177538	STUD, trigger	2
105a	179722	RETAINER, spring	1	120	105334	NUT, lock, hex	2
105b	179731	ELEMENT, strainer	1	121▲	222385	WARNING CARD (not shown)	1
105c	179763	SPRING, compression	1	123▲	187348	COVER, warning	1
105d	179750	RETAINER, spring	1				
106✓	179733	SEAL, sleeve	1				
107	107110	LOCKNUT	1				
108	197052	ADAPTER, RAC	1				
110	197058	BRACKET, stem	1				

▲ Replacement Danger and Warning labels, tags and cards are available at no cost.

✓ Keep these spare parts on hand to reduce down time.

● Part number provided for reference only. Not available as a replacement part.



# Parts

Contractor™ In-line Valve Model 244161

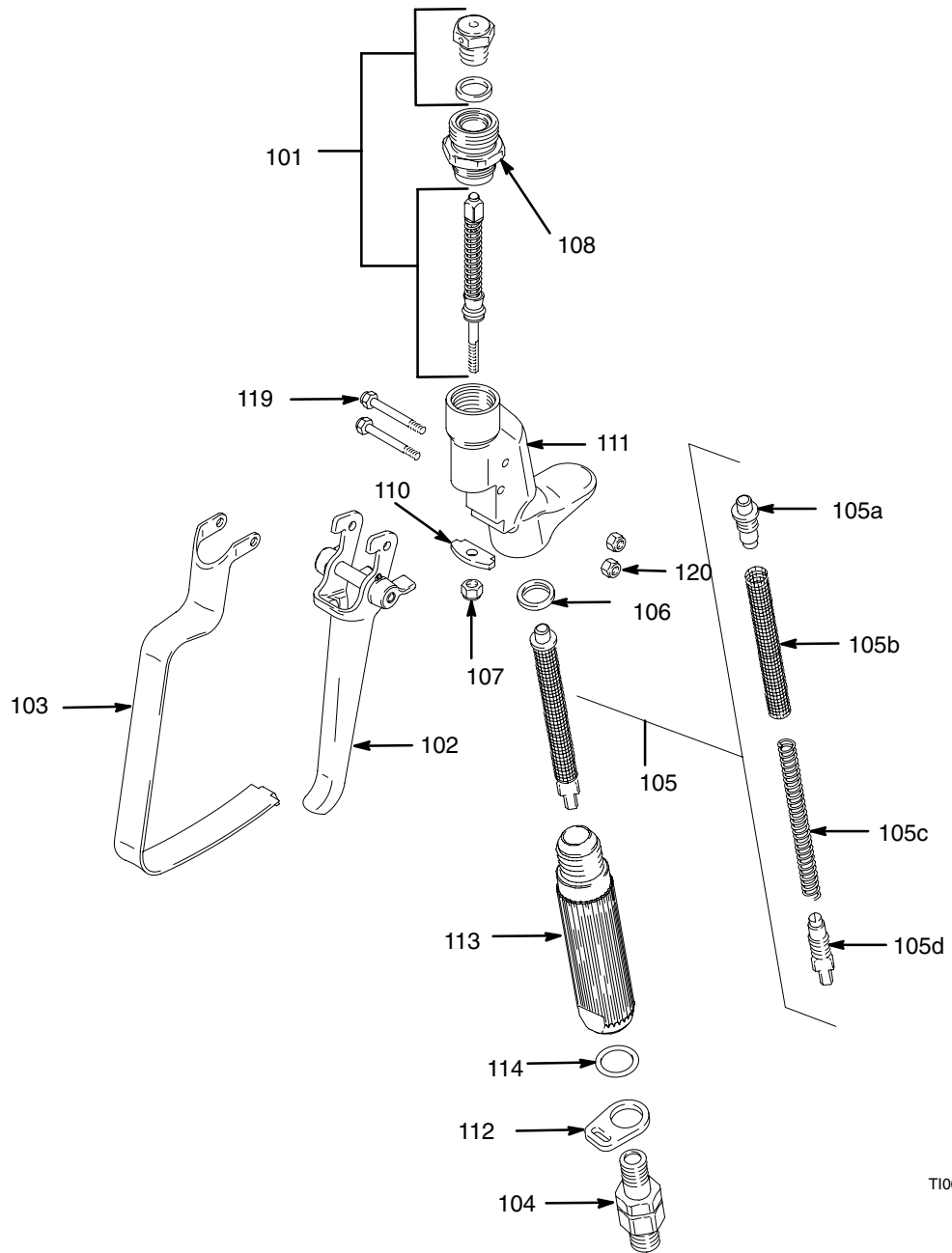

T10667

# Technical Data

Maximum fluid working pressure – sprayer	2800 psi (19 MPa, 193 bar)
Maximum fluid working pressure – Contractor™ In-line Valve, extension, roller*	3600 psi (25 MPa, 248 bar)
Sprayer inlet size	3/4 in. internal thread (standard garden hose)
Sprayer outlet size	1/4 npsm external thread
Contractor™ In-line Valve fluid inlet size	1/4 npsm (swivel)
Contractor™ In-line Valve fluid outlet size	7/8–14 unf
Electric motor	3/8 hp 7A open frame universal
Sprayer weight only	13 lb (6 kg)
Dimensions	
Length	14.9 in. (37.8 cm)
Width	15.0 in. (38.1 cm)
Height	15.6 in. (39.6 cm)
Wetted parts sprayer	stainless steel, brass, ultra-high molecular weight polyethylene (UHMWPE), leather carbide, nylon, aluminum, PVC, polypropylene, fluoroelastomer
Wetted parts Contractor™ In-line Valve	UHMWPE, aluminum, tungsten carbide, stainless steel, PTFE, brass
Inlet Screen on Suction Tube	35 mesh (450 microns)
Maximum material temperature	120°F (50°C)
Contractor™ In-line Valve fluid Valve orifice size	0.125 in. (2.286 mm) dia.
Electrical power requirement	120V AC, 60 Hz, 1 phase, 15A
Sound data * Contractor™ In-line Valve	
Sound pressure level	78 dB(A)
Sound power level	87 dB(A)
* Measured while spraying waterbase paint – specific gravity 1.36 through a 517 tip at 3,000 psi (21 MPa, 207 bar) per ISO 3744. Actual sound levels may vary with length of extension used.	
* <i>The best operating pressure is the lowest pressure that provides an even paint supply to the roller and typically does not exceed 300 psi (2.1 MPa, 21 bar).</i>	



# Graco Standard Warranty

Graco warrants all equipment manufactured by Graco and bearing its name to be free from defects in material and workmanship on the date of sale to the original purchaser for use. With the exception of any special, extended, or limited warranty published by Graco, Graco will, for a period of twelve months from the date of sale, repair or replace any part of the equipment determined by Graco to be defective. This warranty applies only when the equipment is installed, operated and maintained in accordance with Graco's written recommendations.

This warranty does not cover, and Graco shall not be liable for general wear and tear, or any malfunction, damage or wear caused by faulty installation, misapplication, abrasion, corrosion, inadequate or improper maintenance, negligence, accident, tampering, or substitution of non-Graco component parts. Nor shall Graco be liable for malfunction, damage or wear caused by the incompatibility of Graco equipment with structures, accessories, equipment or materials not supplied by Graco, or the improper design, manufacture, installation, operation or maintenance of structures, accessories, equipment or materials not supplied by Graco.

This warranty is conditioned upon the prepaid return of the equipment claimed to be defective to an authorized Graco distributor for verification of the claimed defect. If the claimed defect is verified, Graco will repair or replace free of charge any defective parts. The equipment will be returned to the original purchaser transportation prepaid. If inspection of the equipment does not disclose any defect in material or workmanship, repairs will be made at a reasonable charge, which charges may include the costs of parts, labor, and transportation.

**THIS WARRANTY IS EXCLUSIVE, AND IS IN LIEU OF ANY OTHER WARRANTIES, EXPRESS OR IMPLIED, INCLUDING BUT NOT LIMITED TO WARRANTY OF MERCHANTABILITY OR WARRANTY OF FITNESS FOR A PARTICULAR PURPOSE.**

Graco's sole obligation and buyer's sole remedy for any breach of warranty shall be as set forth above. The buyer agrees that no other remedy (including, but not limited to, incidental or consequential damages for lost profits, lost sales, injury to person or property, or any other incidental or consequential loss) shall be available. Any action for breach of warranty must be brought within two (2) years of the date of sale.

Graco makes no warranty, and disclaims all implied warranties of merchantability and fitness for a particular purpose in connection with accessories, equipment, materials or components sold but not manufactured by Graco. These items sold, but not manufactured by Graco (such as electric motors, switches, hose, etc.), are subject to the warranty, if any, of their manufacturer. Graco will provide purchaser with reasonable assistance in making any claim for breach of these warranties.

In no event will Graco be liable for indirect, incidental, special or consequential damages resulting from Graco supplying equipment hereunder, or the furnishing, performance, or use of any products or other goods sold hereto, whether due to a breach of contract, breach of warranty, the negligence of Graco, or otherwise.

## **FOR GRACO CANADA CUSTOMERS**

The parties acknowledge that they have required that the present document, as well as all documents, notices and legal proceedings entered into, given or instituted pursuant hereto or relating directly or indirectly hereto, be drawn up in English. Les parties reconnaissent avoir convenu que la rédaction du présente document sera en Anglais, ainsi que tous documents, avis et procédures judiciaires exécutés, donnés ou intentés à la suite de ou en rapport, directement ou indirectement, avec les procédures concernées.

**TO PLACE AN ORDER**, contact your Graco distributor, or call this number to identify the distributor closest to you:  
**1-800-690-2894 Toll Free**

*All written and visual data contained in this document reflects the latest product information available at the time of publication.  
Graco reserves the right to make changes at any time without notice.*

MM 309388

**Graco Headquarters:** Minneapolis  
**International Offices:** Belgium, China, Japan, Korea

**[www.graco.com](http://www.graco.com)**

Written in USA 7/2001, Rev 9/2006